

LASER PEGS®

The Ultimate Construction Toy For Kids®

**ZD 140B
PLANES
AGES 5+**

6 Models+
Any creation you can build

LIGHTED
CONSTRUCTION SET INCLUDES:

- 2 Laser Pegs®
- 60 Tinted Bricks
- Zippy Do® Power Base
- Instruction Manual

Please read this manual before you begin! Failure to follow this manual's instructions may result in damage to the Zippy Do® Power Base and/or the Zippy Do® pieces. Not adhering to these instructions will void the manufacturer's warranty. The packaging must be kept because it contains important information.

WARNING: CHOKING HAZARD-Small parts. Not for children under 3 yrs. Do not submerge in water.

WARNING: STROBE LIGHTS MAY CAUSE SEIZURES

Requires 3-LR44 Batteries **DO NOT SUBMERGE IN WATER**

Batteries Included

EN71, RoHS COMPLIANT

This product complies to all safety requirements of ASTM F 963



Laser Pegs® Parts List

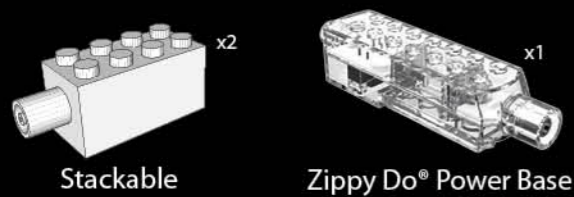

Stackable

Zippy Do® Power Base

The toy is not to be connected to more than the recommended number of power supplies

Tinted Bricks List

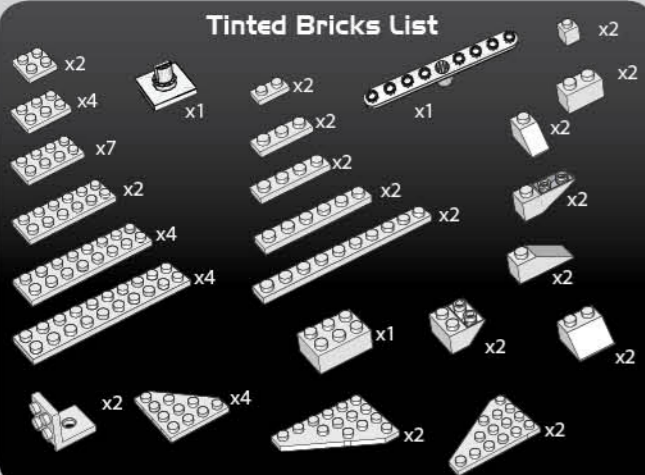

www.LaserPegs.com

This manual is copyright and cannot be reproduced or used online without Laser Pegs® Ventures LLC permission. Copyright 2014 © All Rights Reserved US Patent #7,731,558 Additional Global & Multiple Patents Pending. Laser Pegs® Ventures LLC, 8304 Consumer Ct Sarasota FL, 34240. Contact: Support@LaserPegs.com

Connecting Pegs

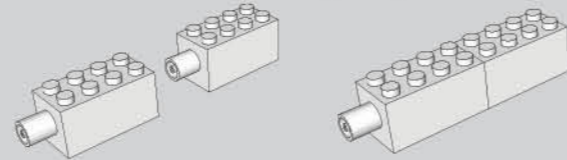

To construct with Laser Pegs®, slide two pieces together to form a connection. Slide each piece on and off smoothly. (Laser Pegs® pieces sold separately).

*To avoid short-circuits, keep metal objects and other unauthorized materials from obstructing the peg holes.

Slide Power Switch to turn on/off/flash

Slide Power Switch to cycle through different light settings.

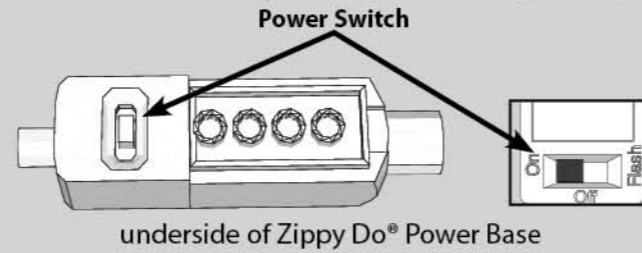

underside of Zippy Do® Power Base

This Product contains a button battery. If swallowed, it could cause severe injury or death in just 2 hours. Seek medical attention immediately.

Replacing Batteries

1. Remove the Phillips head screw.
2. Remove the Battery Compartment Cover.
3. Place three (3) LR44 batteries in the correct position. (Batteries are to be inserted with the correct polarity).
4. Replace the Battery Compartment Cover.
5. Replace the Phillips head screw.
6. Slide Power Switch to turn on!
7. Do not mix old and new batteries.
8. Do not mix alkaline, standard (carbon-zinc), or rechargeable (nickel-cadmium, NiMH) batteries!
9. Exhausted batteries are to be removed from the power base.
10. Batteries should be recycled or disposed of as per state and local guidelines.
11. Non-rechargeable batteries are not to be recharged.
12. Rechargeable batteries are only to be recharged under adult supervision.
13. Rechargeable batteries are to be removed from the toy before being recharged.
14. The supply terminals are not to be short-circuited.
15. Do NOT throw batteries into fire!

Remove the Phillips head screw with a 4mm screw driver.

Requires 3-LR44 Button Cell Batteries

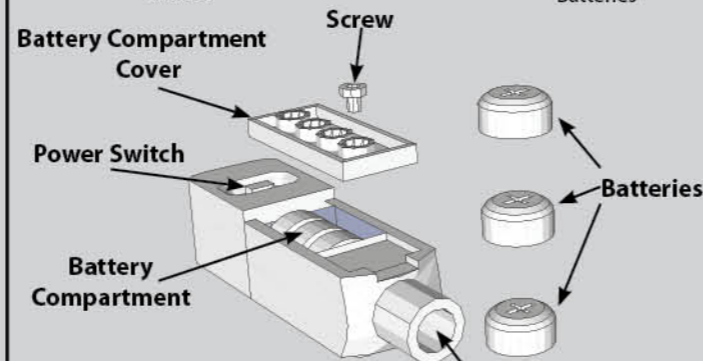

BATTERIES ARE TO BE INSERTED INTO THE TOY BY AN ADULT ONLY!

Connects to other Laser Pegs® pieces

ONLY ADULTS SHOULD INSTALL THE BATTERIES

WARTHOG: A twin-engine, straight-wing aircraft known as "the most survivable plane ever built".



WARTHOG

Model Difficulty Level

3

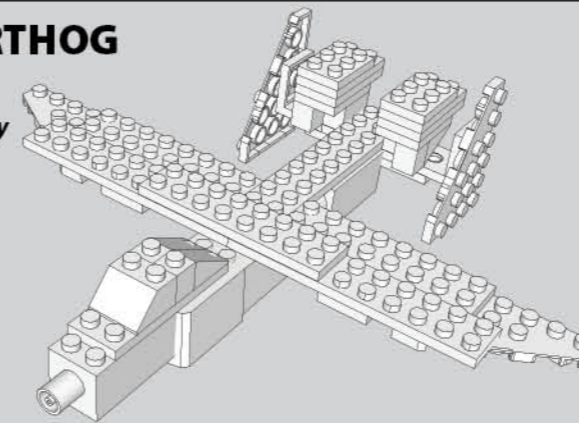

STEP 1

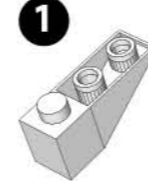

STEP 2

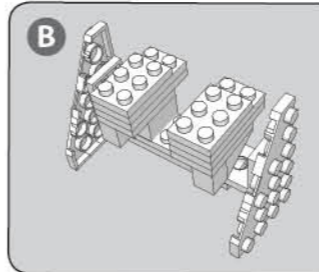
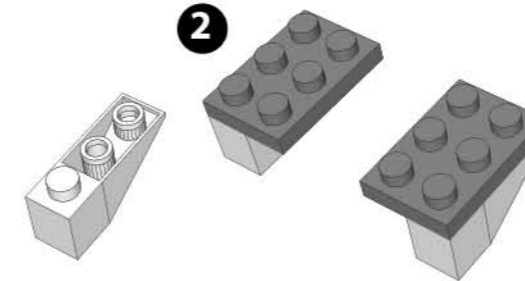

STEP 3

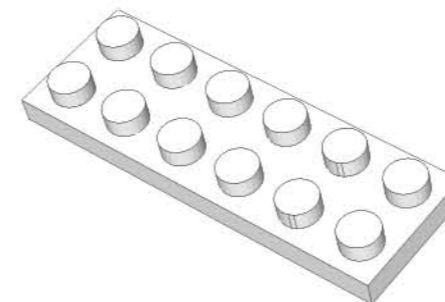

COMBINE PARTS



FLIP MODEL OVER

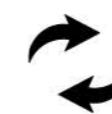

ROTATE MODEL

STEP 4

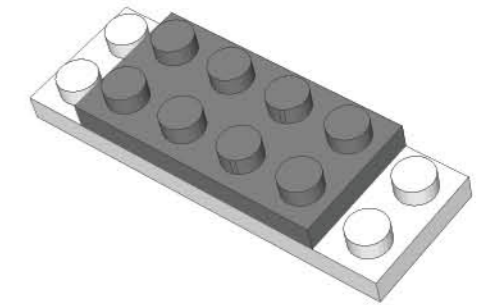

STEP 5

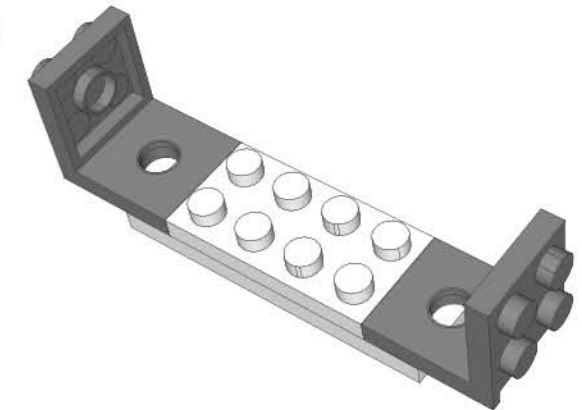

STEP 6

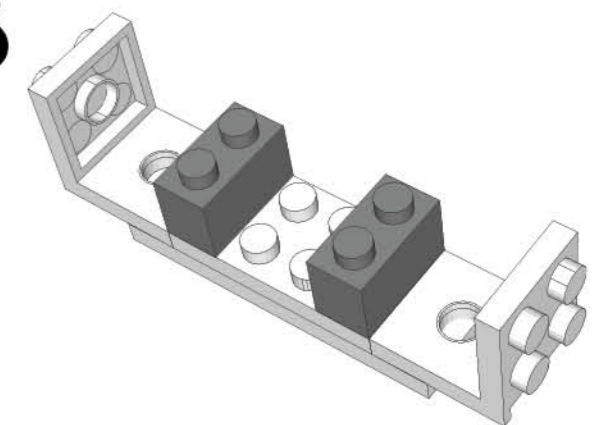

STEP 7

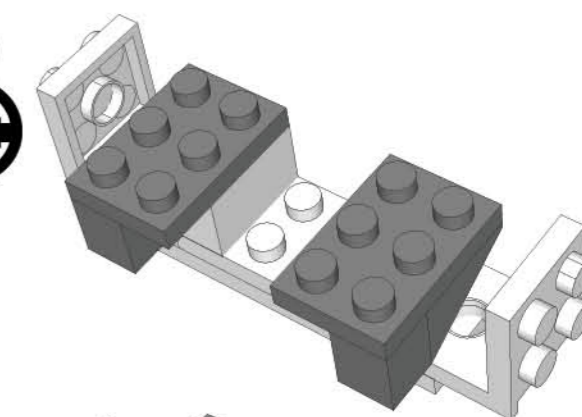

STEP 8

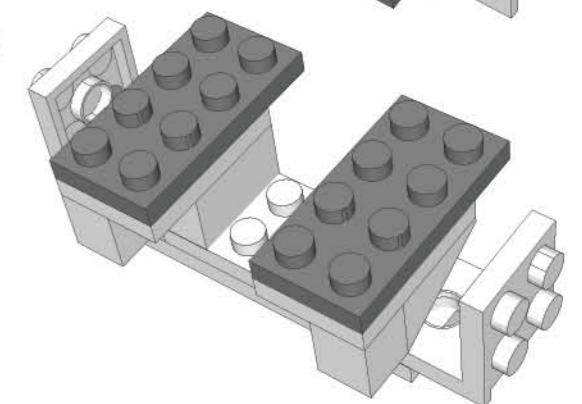

STEP 9

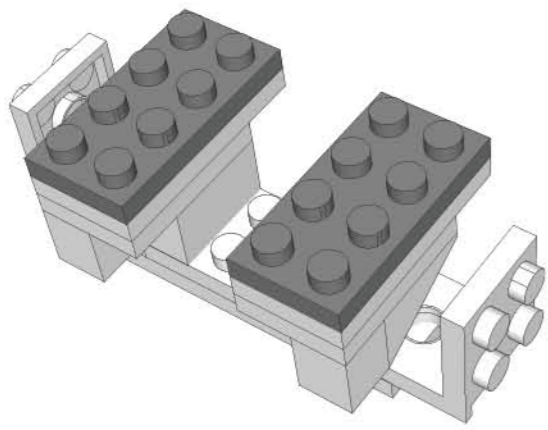

STEP 10

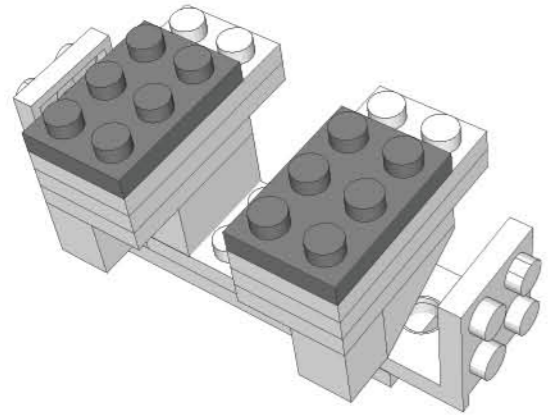

STEP 11

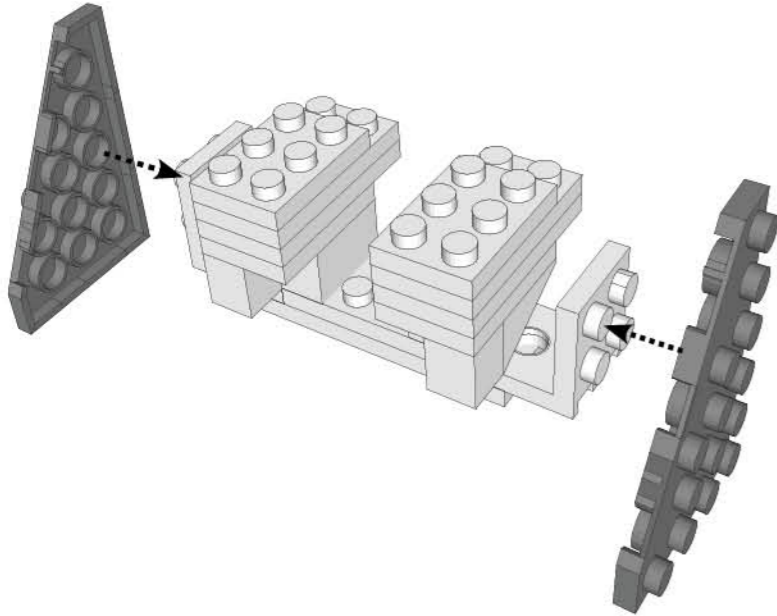

STEP 12

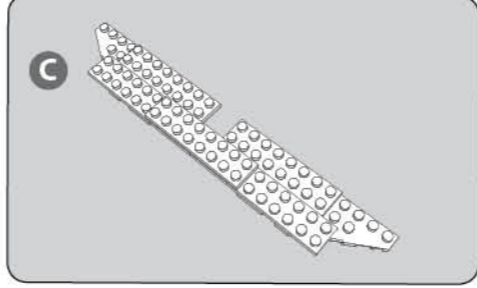
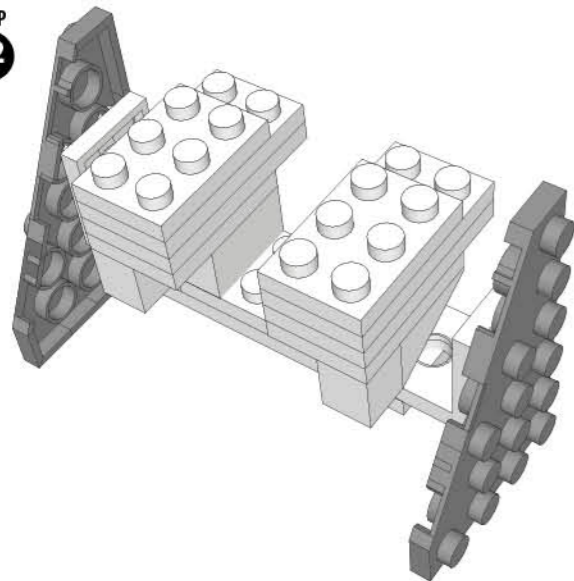

STEP 13

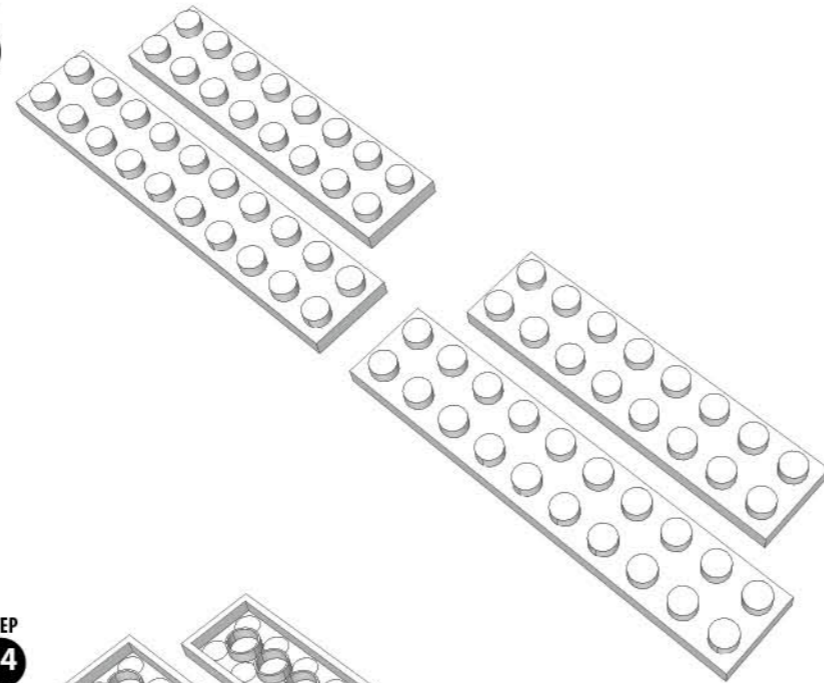

STEP 14

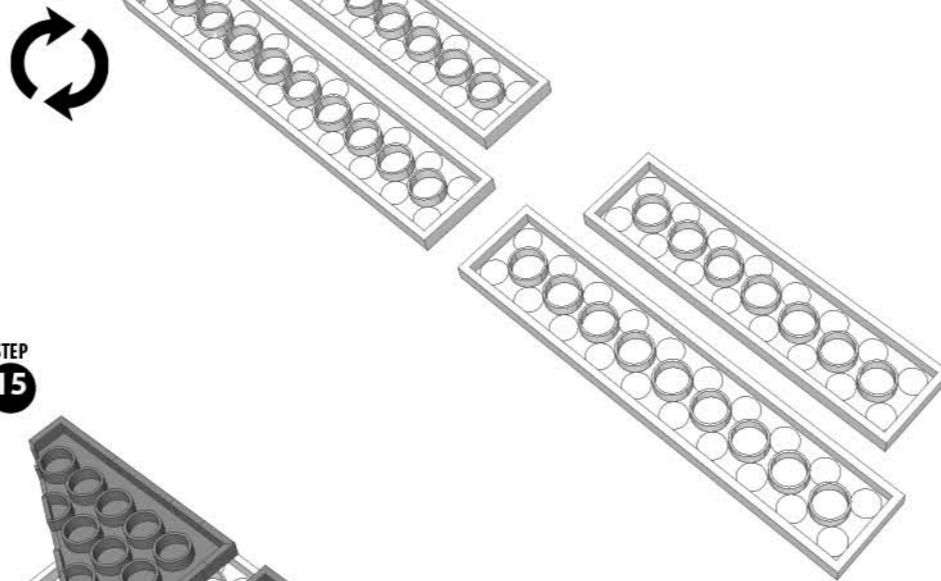

STEP 15

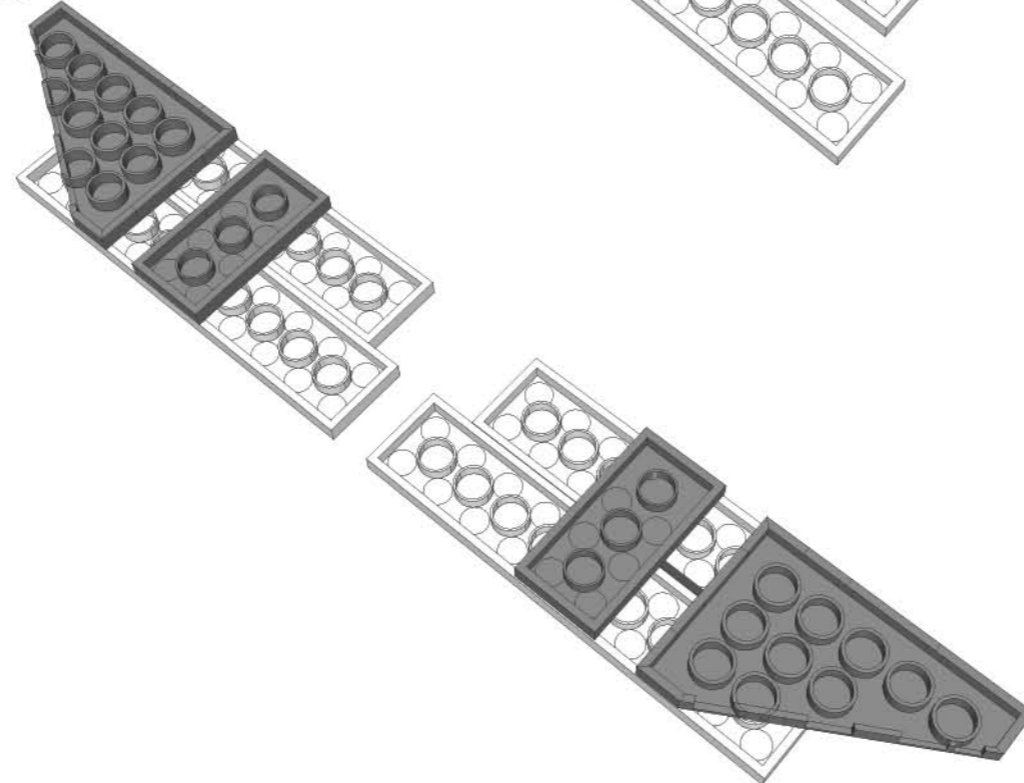

STEP 16

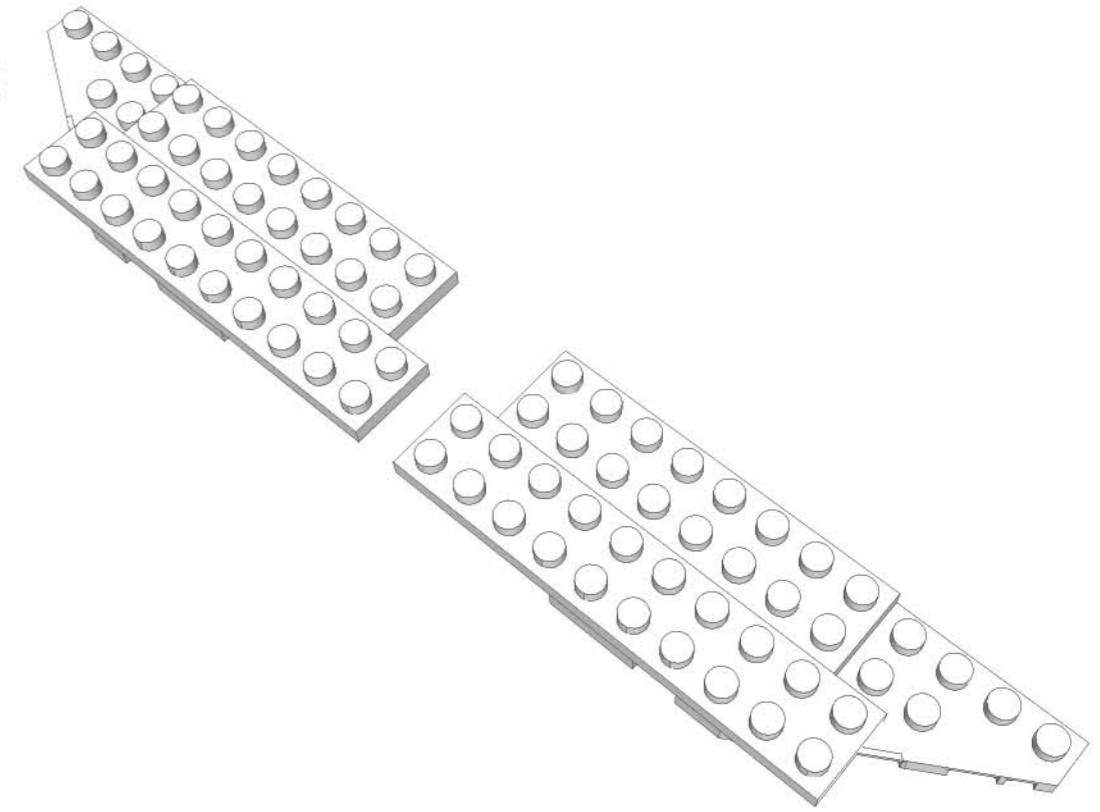

STEP 17

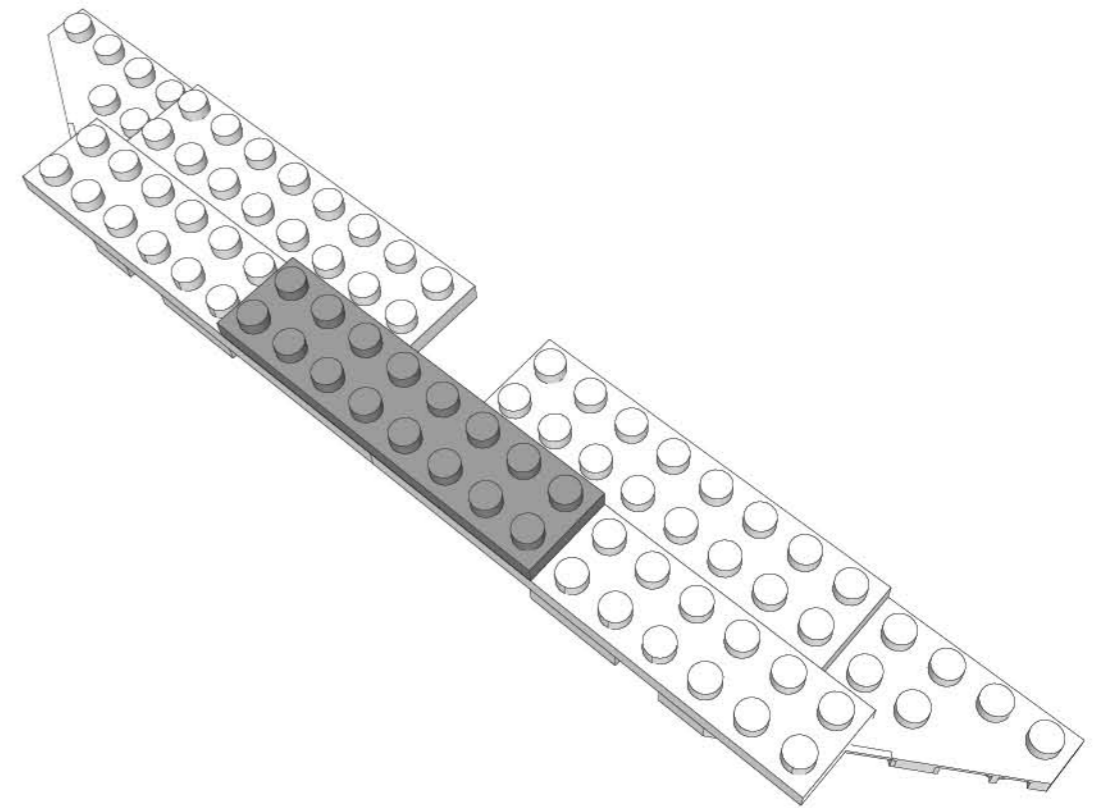

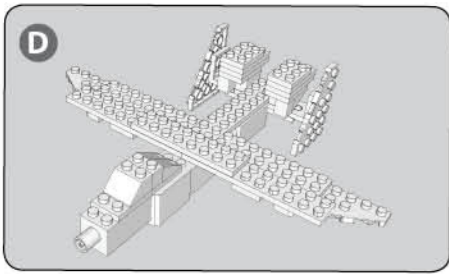

STEP 18

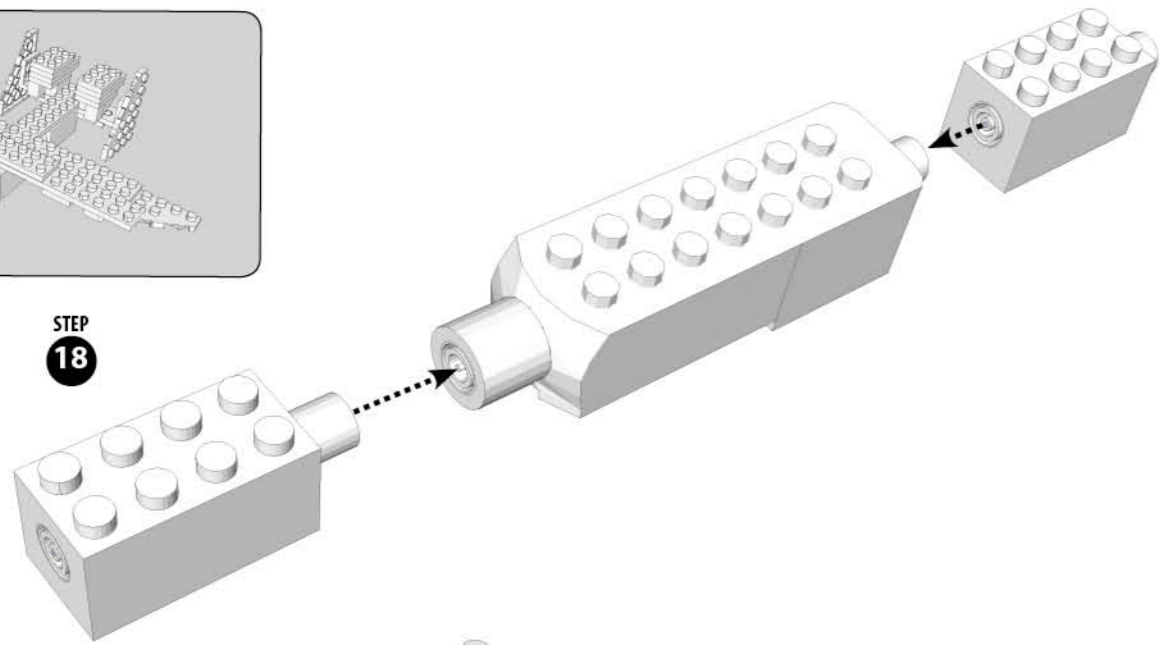

STEP 19

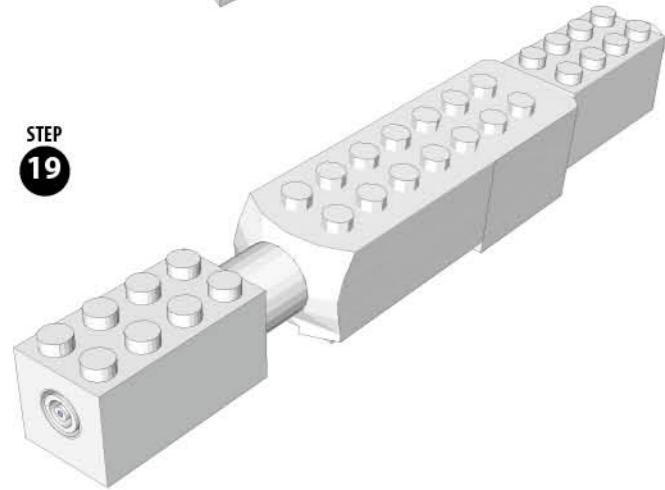

STEP 20

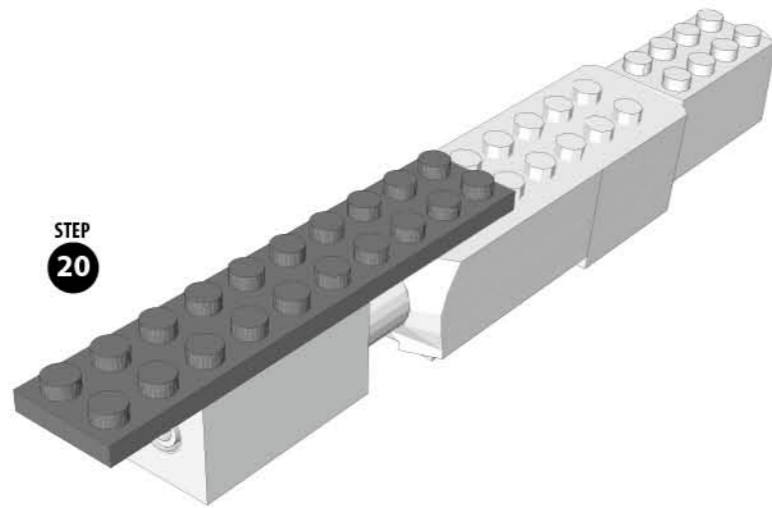

STEP 21

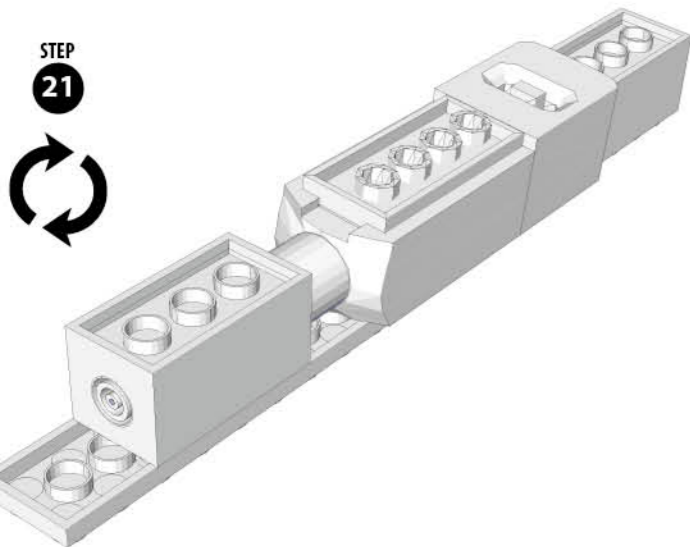

STEP 22

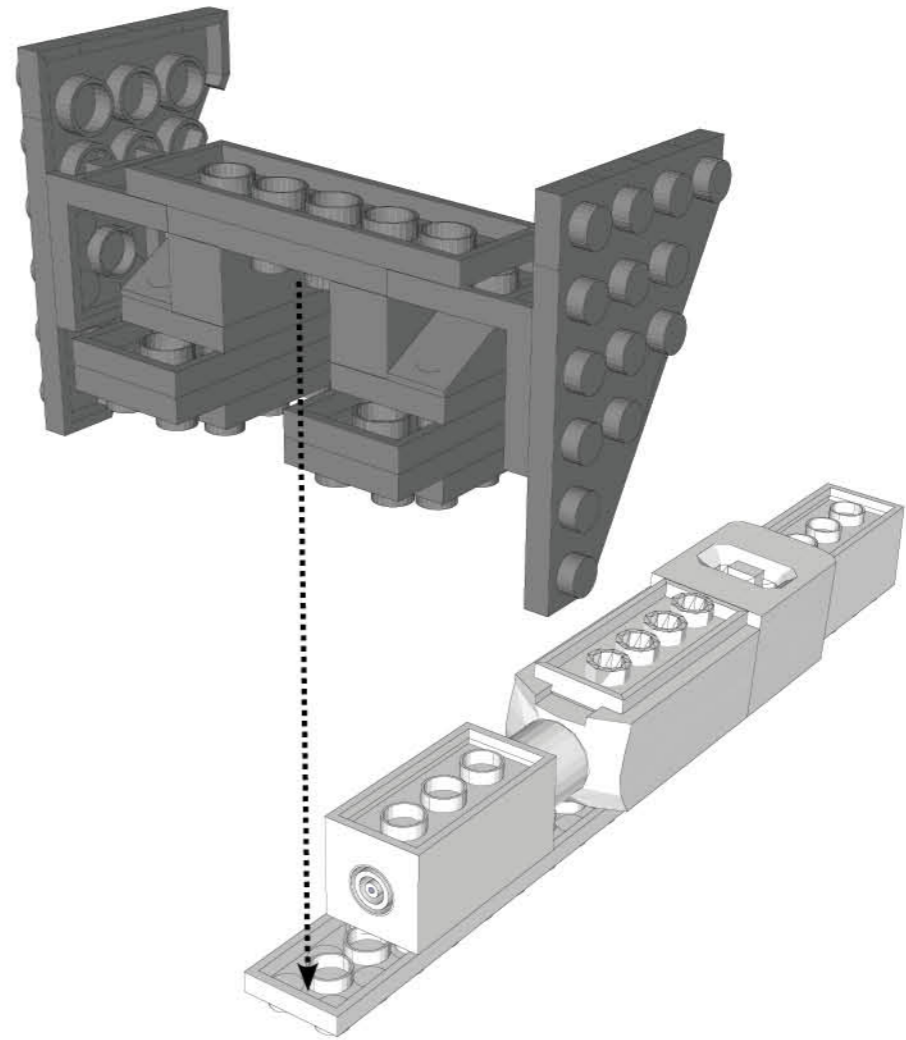

STEP 23

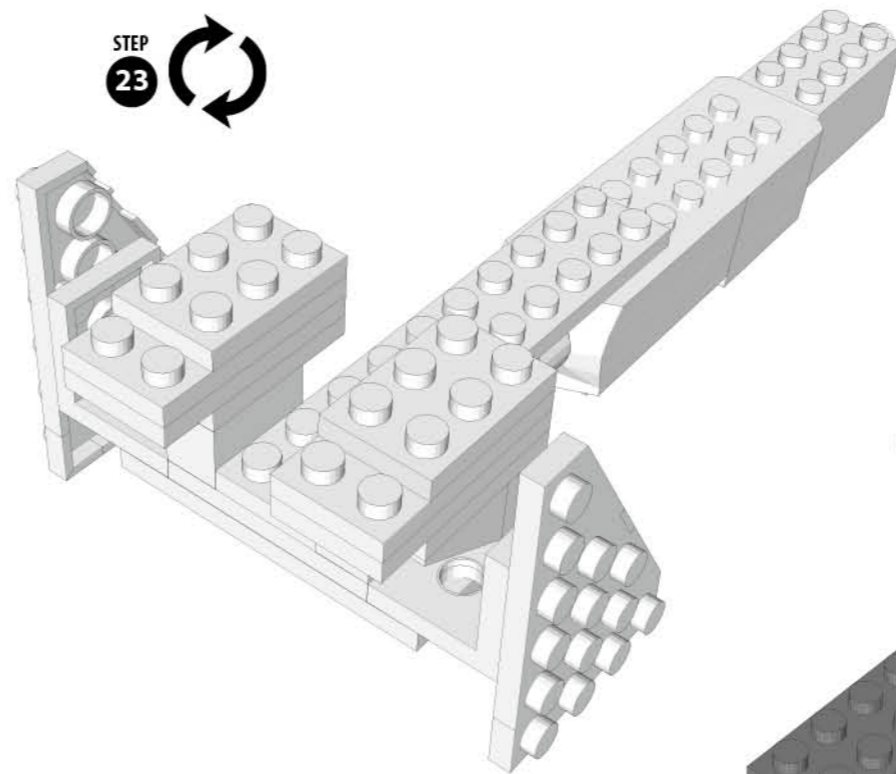

STEP 24

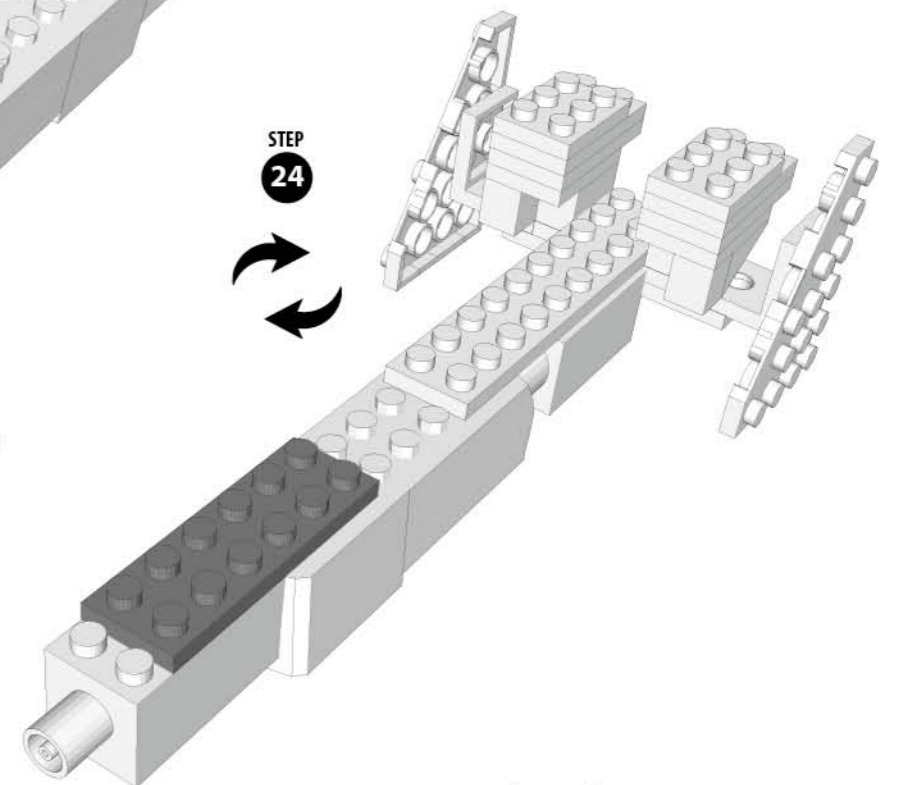
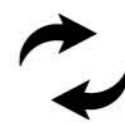

STEP
25

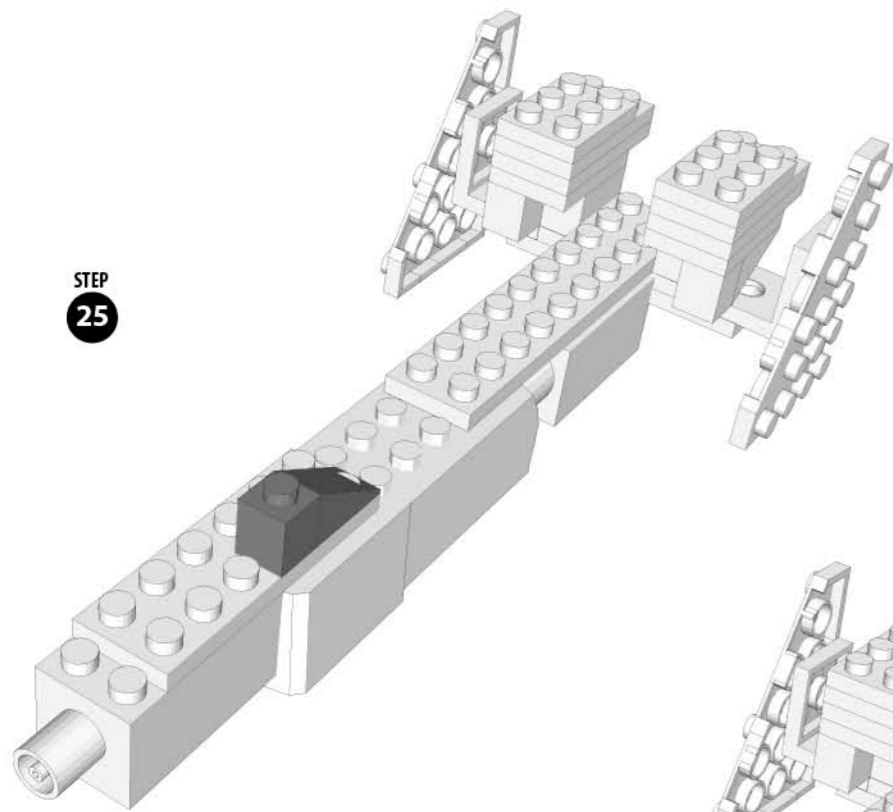

STEP
26

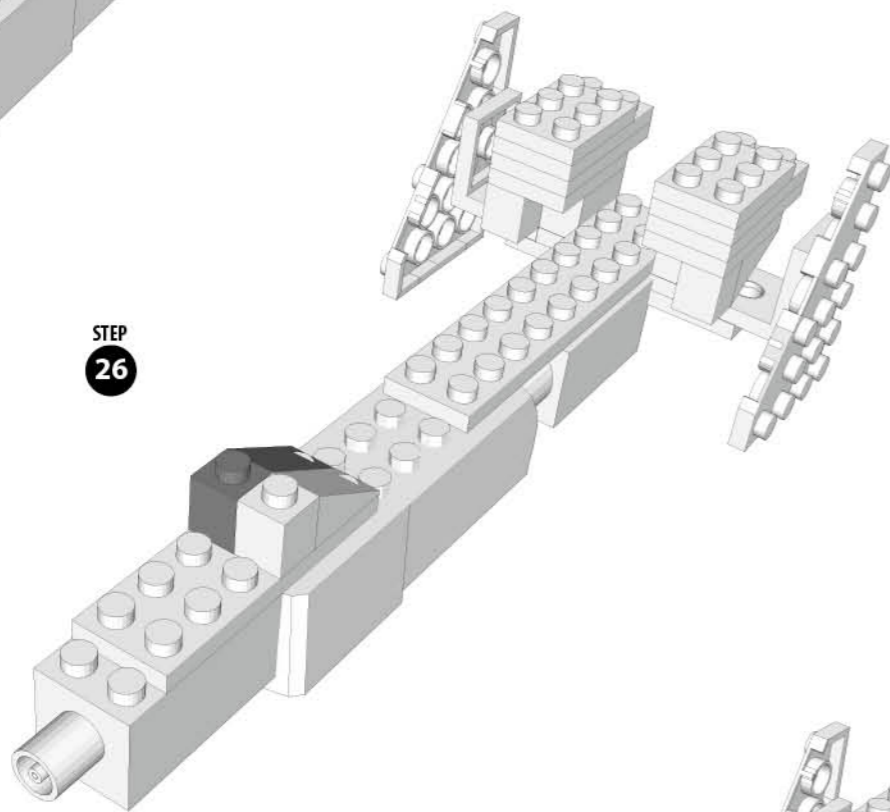

STEP
27

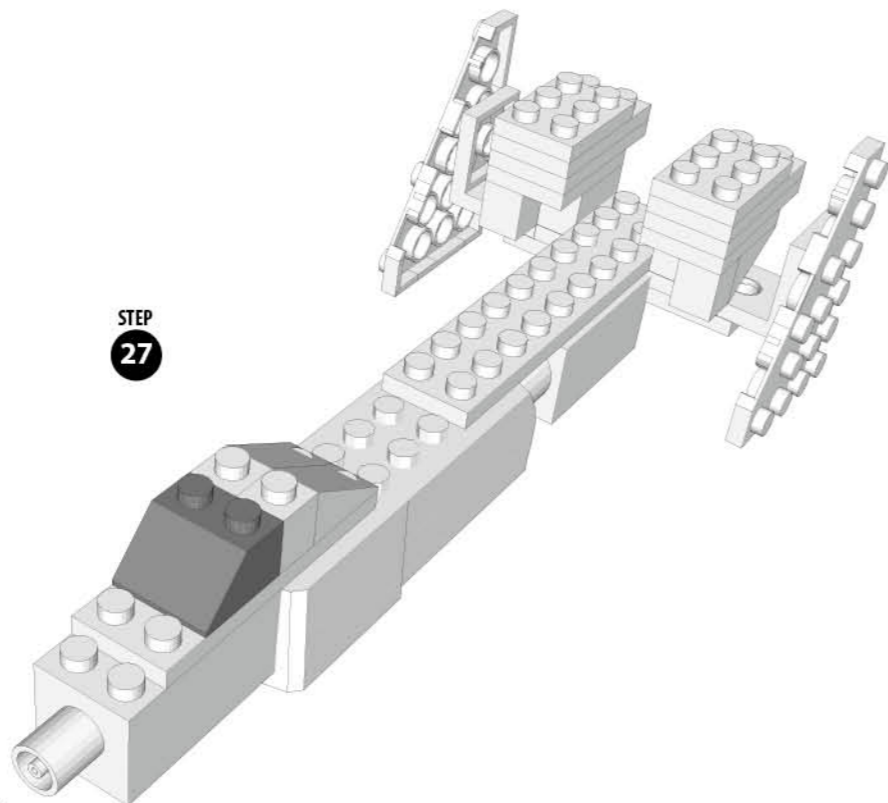

STEP
28

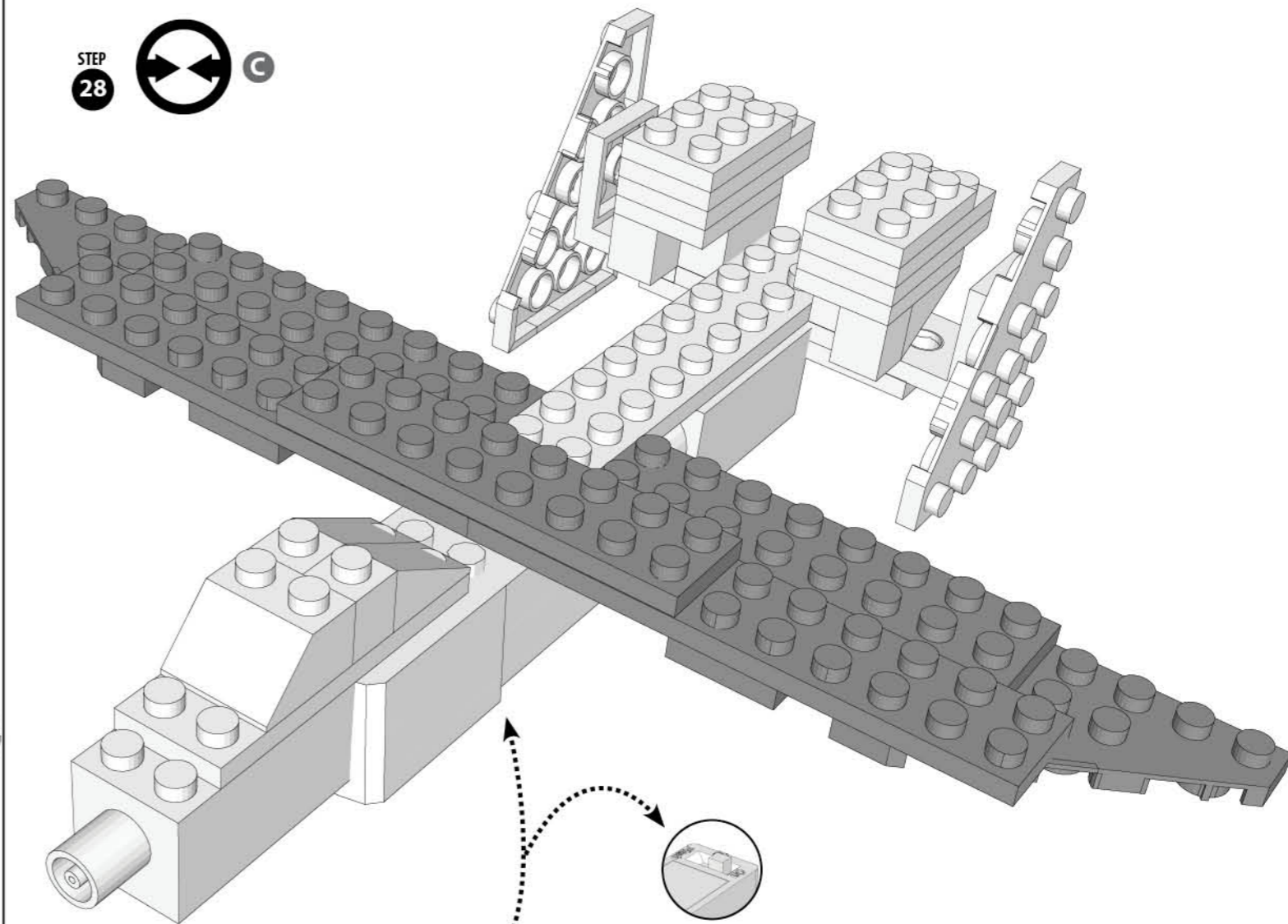

Slide the switch to Light It Up

Environmental Phenomena

*The unit may malfunction if subjected to radio-frequency interference. It SHOULD revert to normal operation when the interference stops. If not, it may become necessary to turn the power off and back on, or remove and reinstall the batteries.

*In the unlikely event of an electrostatic discharge, the unit may malfunction and lose memory, requiring the user to reset the device by removing and reinstalling the batteries.

Laser Pegs® CARES
Questions? Comments?
For additional compliance info:
1-866-432-3735
Contact: Support@LaserPegs.com

MADE IN CHINA

www.LaserPegs.com
Copyright 2014 © All Rights Reserved Global & Multiple Patents Pending.
US Patent #7,731,558